

FEATURES

- Open VPX VITA 62 compliant
- 6U VPX, 1.0" pitch single slot
- Wide input range: 18-36V
- Input transient protection
- Two high power DC outputs:
12V/40A, 5V/24A
- Multiple auxiliary DC outputs:
3.3VAux/15A, -12VAux/2A, +12VAux/1A
- Low noise & ripple
- Parallelable output (12V/40A)
- Input-output isolation
- Excellent load regulation
- Overcurrent, Overvoltage, Over temperature protection
- Efficiency of 90% typical
- High power density
- Conduction cooled at card edge
- Conformal coating on PCB
- MIL-STD-461F, CE-102 compliant with external filter
- ENABLE*, INHIBIT* controls per VITA 62
- Output voltage FAIL* signal
- LED indication



OVERVIEW

The Behlman VPXtra™1000CM series COTS DC to DC power supply is a rugged, highly reliable, conduction cooled, switch mode unit built for high-end industrial and military applications. The VPXtra™1000CM is a VITA 62, Open VPX compliant, 6U, power supply that delivers 700 Watts of DC power via five outputs. 12V output can be paralleled for higher power and redundancy. The VPXtra™1000CM accepts 28 VDC input, IAW MIL-STD-704, and can supply a high power DC output at various power levels dependent on cooling capability.

The VPXtra™1000CM power supply has no minimum load requirement and has overvoltage and short circuit protection as well as over current and thermal protection. The power supply is designed to support the rigors of mission critical airborne, shipboard, vehicle and mobile applications.

Designed and manufactured with Xtra-Cooling™ technology, Xtra-Reliable™ design and Xtra-Rugged™ construction makes the Behlman VPXtra™ 1000CM your best choice.

Absolute Maximum Ratings:

(Stresses above those listed below may cause permanent damage to the unit)

Parameter	Notes	Min	Typical	Max	Units
Input Voltage		18		36	V
Input Current				52	A
Operating Temperature	Measured at Card Edge	-40		71	°C
Storage Temperature		-40		105	°C
Isolation Voltage	Input to Output			500	V
Isolation Voltage	Input to Case			500	V
Isolation Voltage	Output to Case			100	V
Isolation Resistance	Input to Case	10			MΩ

Input Characteristics:

Parameter	Notes	Min	Typical	Max	Units
Operating Input Voltage Range		18	28	36	V
Turn-On Threshold			17.6		V
Turn-Off Threshold			16.9		V
Input Standby Current	28V Input, Enable De-asserted (Input Off), Inhibit Asserted (Output Off)		0.13		A
Input Standby Current	28V Input, Enable Asserted (Input On), Inhibit Asserted (Output Off)		0.14		A
Input No Load Current	28V Input, Enable Asserted (Input On) and Inhibit De-asserted (Output On)		0.65		A

Output Characteristics, +12V/40A Output:

Parameter	Notes	Min	Typical	Max	Units
Output Voltage Set Point		11.80	12.00	12.17	V
Line Regulation	(18-36V input range, 100% Output Load)		0.05	0.25	%
Load Regulation	(28V input)		0.05	0.25	%
Output Ripple/Noise Peak to Peak	See Note 1		80	120	mVp-p
Output Ripple/Noise RMS	See Note 1			25	mV _{rms}
Max. Capacitive Load				12,000	uF
Output Current Range		0		40	A
Output Voltage Remote Sense Range	Maximum DCR Losses to Remote Sense Connection			10	%
Output Overvoltage Protection		14.2	14.8	15.4	V
Output Overcurrent Protection		46	50	55	A
Transient Response	See Figures 5,8				

Output Characteristics, +5V /24A Output:

Parameter	Notes	Min	Typical	Max	Units
Output Voltage Set Point		4.95	5.00	5.05	V
Line Regulation	(18-36V input range, 100% Output Load)		0.1	0.3	%
Load Regulation	(28V input)		0.75	1	%
Output Ripple/Noise Peak to Peak	See Note 1			50	mVp-p
Output Ripple/Noise RMS	See Note 1			25	mV _{rms}
Max. Capacitive Load				8,000	uF
Output Current Range		0		24	A
Output Overvoltage Protection		5.9	6.1	6.4	V
Output Overcurrent Protection		26	28	30	A
Transient Response	See Figure 7				

Output Characteristics, +3.3V Aux / 15A Output:

Parameter	Notes	Min	Typical	Max	Units
Output Voltage Set Point		3.267	3.300	3.333	V
Line Regulation	(18-36V input range, 100% Output Load)		0.1	0.3	%
Load Regulation	(28V input)		0.75	1	%
Output Ripple/Noise Peak to Peak	See Note 1			50	mVp-p
Output Ripple/Noise RMS	See Note 1			25	mV _{rms}
Max. Capacitive Load				10,000	uF
Output Current Range		0		15	A
Output Overvoltage Protection		4.0	4.3	4.6	V
Output Overcurrent Protection		16.5	18	20	A
Transient Response	See Figure 6				

Output Characteristics, -12V Aux / 2A Output:

Parameter	Notes	Min	Typical	Max	Units
Output Voltage Set Point		-11.88	-12.00	-12.12	V
Line Regulation	(18-36V input range, 100% Output Load)		0.1	0.3	%
Load Regulation	(28V input)		0.75	1	%
Output Ripple/Noise Peak to Peak	See Note 1		60	100	mVp-p
Output Ripple/Noise RMS	See Note 1			25	mV _{rms}
Max. Capacitive Load				1,200	uF
Output Current Range		0		2	A
Output Overvoltage Protection		-15.4	-14.8	-14.2	V
Output Overcurrent Protection			2.5	4	A

Output Characteristics, +12V Aux / 1A Output:

Parameter	Notes	Min	Typical	Max	Units
Output Voltage Set Point		11.4	12.0	12.6	V
Line Regulation	(18-36V input range, 100% Output Load)		1		%
Load Regulation	(28V input)		5		%
Output Ripple/Noise Peak to Peak	See Note 1		60	100	mVp-p
Output Ripple/Noise RMS	See Note 1			25	mV _{rms}
Max. Capacitive Load				12,000	uF
Output Current Range		0	1	1.5	A
Output Overvoltage Protection		14.2	14.8	15.4	V
Output Overcurrent Protection			2	4	A

General Characteristics:

Parameter	Notes	Min	Typical	Max	Units
Power	See Figure 11		700		W
Efficiency 100% Load	12V@40A, 5V@24A, 3.3VAux@15A -12VAux@2A, 12VAux @1A, 28V Input (Fig.9)		90		%
Efficiency 50% Load	12V@20A, 5V@12A, 3.3VAux@7.5A, -12VAux@1A, 12VAux @0.5A, 28V Input		87		%
Turn-On Delay, 3.3V output	From application of input power (ENABLE* is asserted)		40		ms
Turn-On Delay, +12V output	From INHIBIT* de-assertion		65		ms

Controls and Signals (per VITA 62):

Name	Function	Description
ENABLE* (Input)	Input power control	Active Low, referenced to SIG RTN. When asserted, internal input power bus is enabled
INHIBIT* (Input)	Output power control for +12V, +5V, -12V and +12V AUX outputs	Active Low, referenced to SIG RTN. When asserted, +12V, +5V, -12V and +12V outputs are disabled.
FAIL* (Output)	Reports out of tolerance output voltages	Open Drain Output (40V, 10mA) with internal pull-up to 3.3VAux. Logic low indicates output voltage(s) out of tolerance.

Output power status vs. input power and control signals:

Input Power	ENABLE*	INHIBIT*	+12V, +5V, -12VAux, +12VAux outputs	3.3VAux output
Not present	X	X	OFF	OFF
Present	Not asserted (high)	X	OFF	ON
Present	Asserted (low)	Asserted (low)	OFF	ON
Present	Asserted (low)	Not asserted (high)	ON	ON

Indicators:

Indicator	Description
DC IN OK (Green LED)	Indicates Input Power is present
OUT FAULT (Red LED)	Indicates at least one Output Voltage is outside of specified range
DC OUT (Green LED)	Indicates +12V, +5V, -12VAux, +12VAux outputs are enabled
TEMP FAULT (Red LED)	Indicates Power Supply is nearing over temperature shutdown point

Note 1: Ripple and noise measured at output connector, across parallel connection of 10uF tantalum and 0.1uF ceramic capacitors, 20MHz Bandwidth

Note 2: All measurements are performed at Nominal Input (28VDC) and at ambient temperature of 25° C, unless otherwise specified.

Output voltages start up sequence

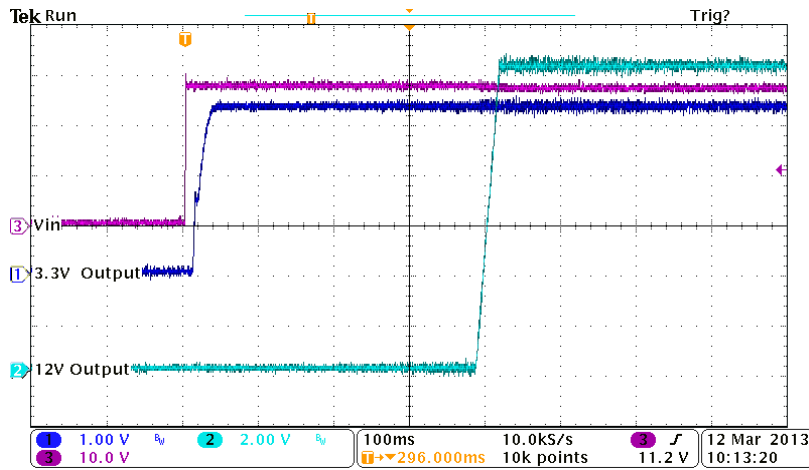

Figure 1: +3.3VAux and +12V Turn-on delay after application of input power, ENABLE* asserted, INHIBIT* de-asserted

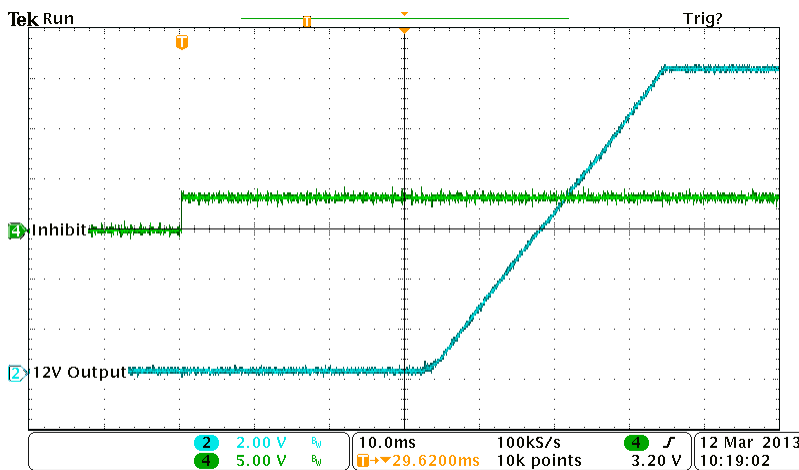

Figure 2: +12V output Turn-on delay from INHIBIT de-assertion

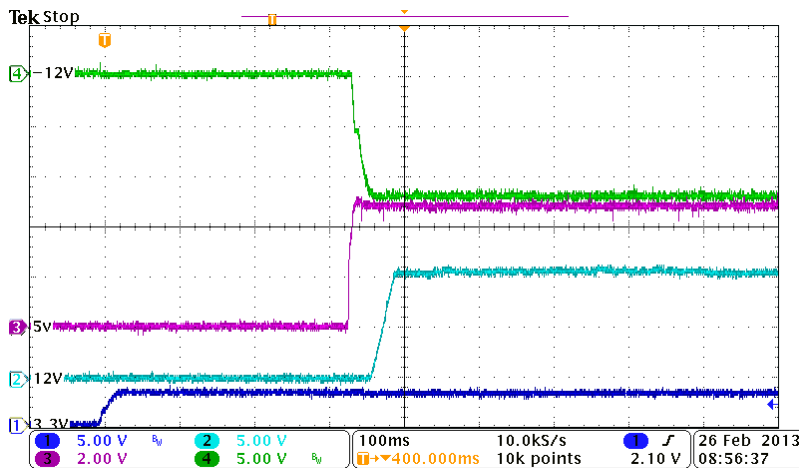

Figure 3: +5V and Auxiliary outputs Turn-on delay after application of input power, ENABLE* asserted, INHIBIT* de-asserted

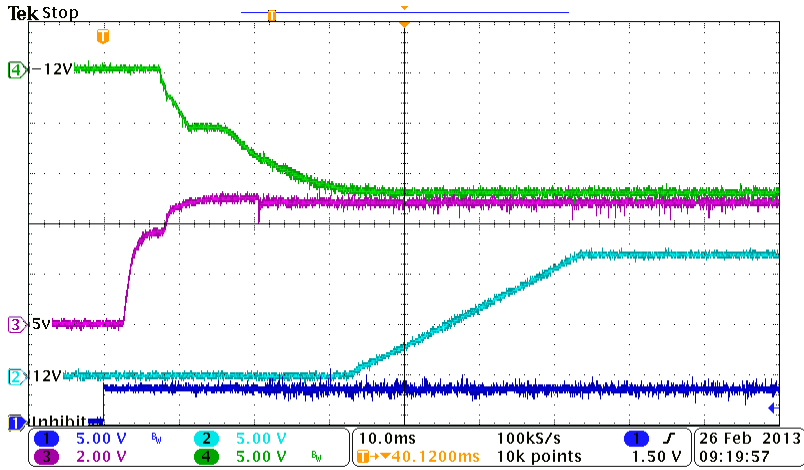

Figure 4: Output voltages turn-on after de-asserting INHIBIT*

Output voltages load transient response:

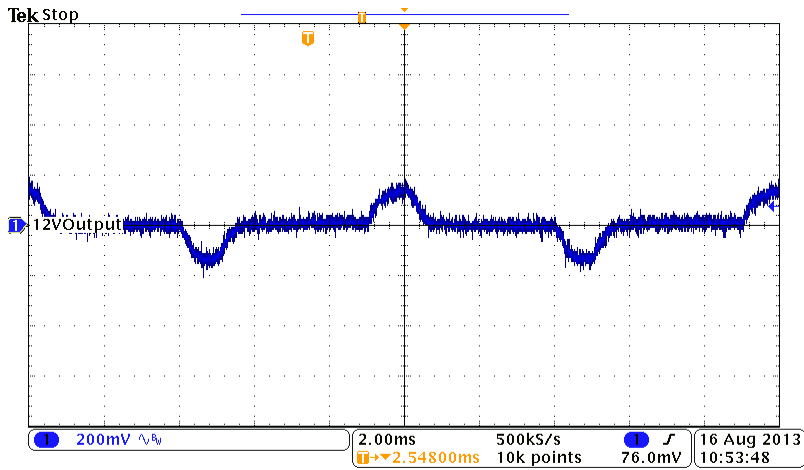

Figure 5: +12V output transient response, 50-75% load change

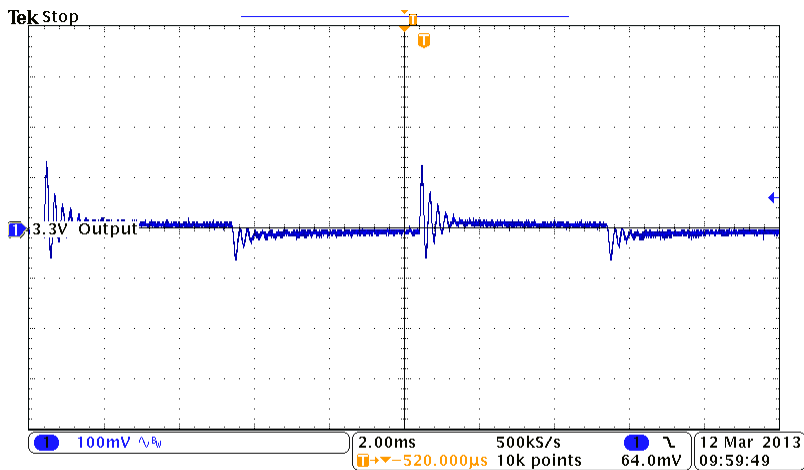

Figure 6: 3.3VAux output transient response, 50-75% load change

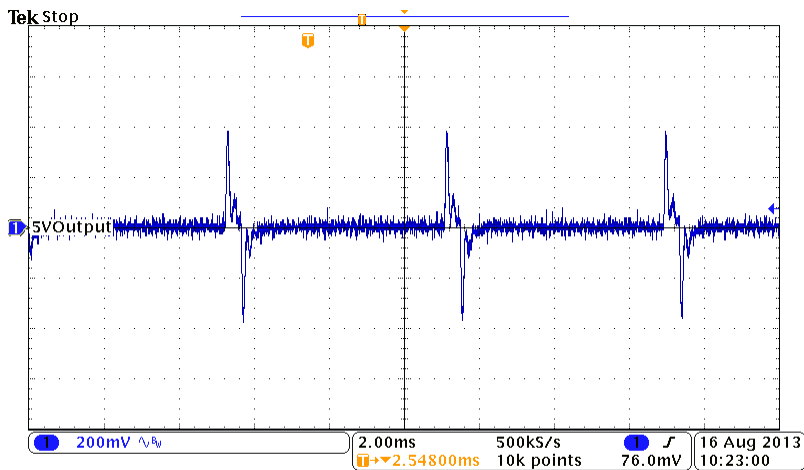

Figure 7: 5V output transient response, 50-75% load change

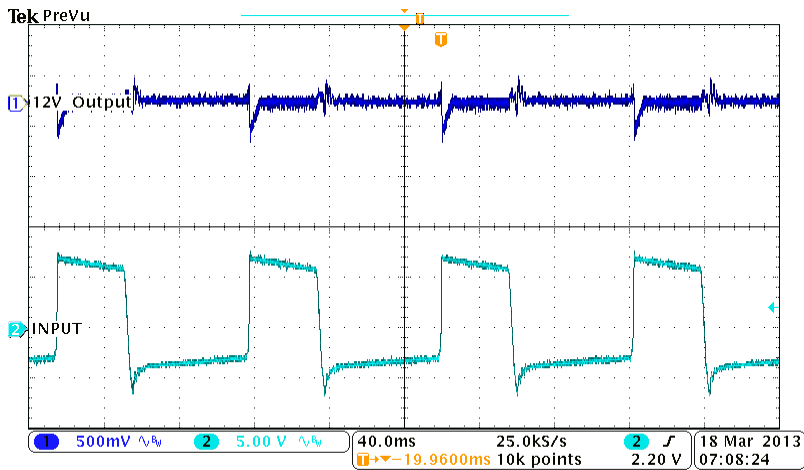

Figure 8: +12V output transient response, Input line change 24 to 34V

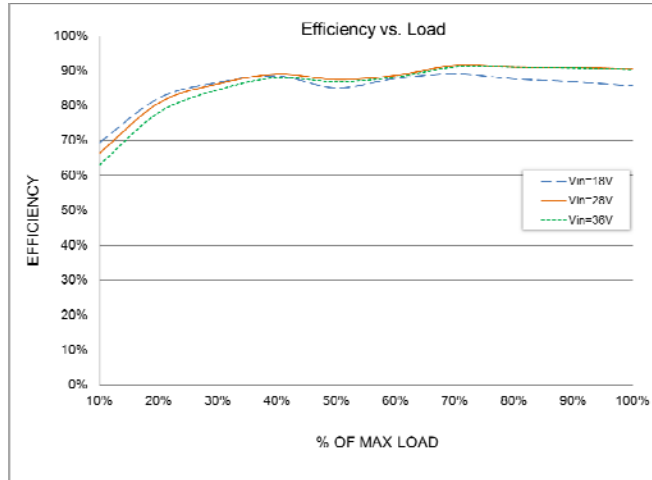

Figure 9: Efficiency vs. Load for Minimum, Nominal and Maximum input voltage

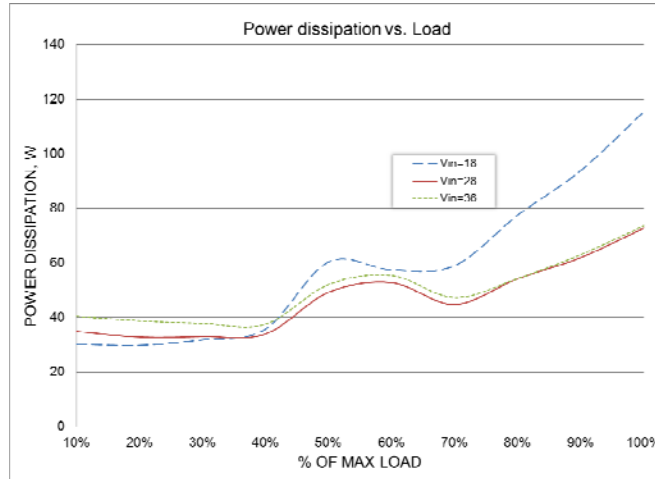

Figure 10: Power dissipation vs. Load for Minimum, Nominal and Maximum input voltage

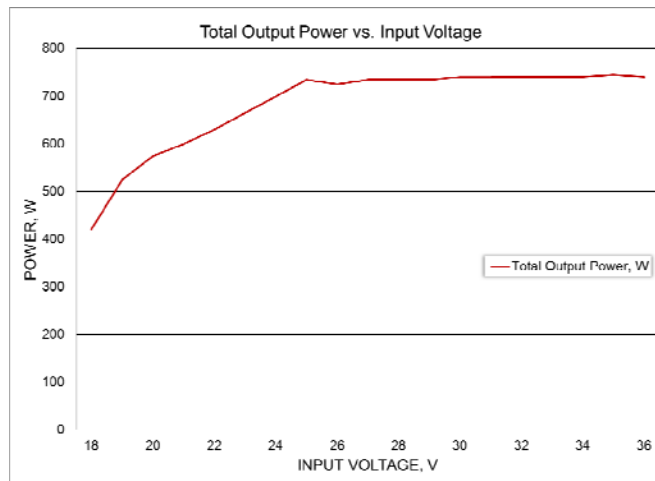

Figure 11: Maximum Output Power vs. Input Voltage (71°C Card Edge Temperature)

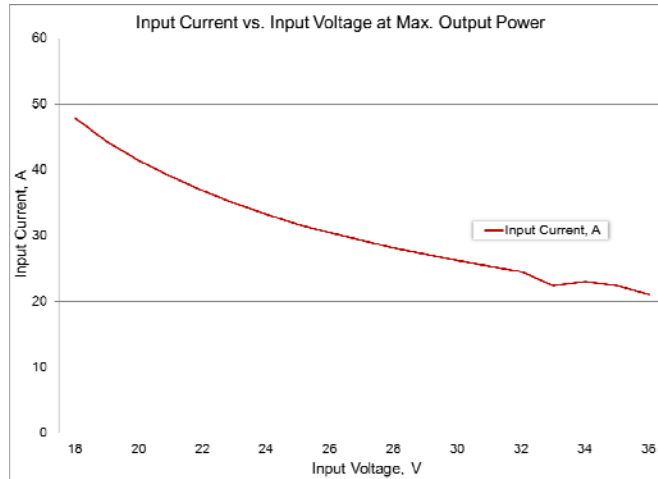

Figure 12: Input Current vs. Input Voltage at maximum output loads.

Paralleling options

The high power +12V/40A output of Behlman VPXtra™1000CM series power supplies can be paralleled for higher output power and redundancy with +12V output of another VPXtra™1000CM or VPXtra™1000CD. Two options are available for the system designers:

- Digital share control (Standard)
Digital share control provides superior sharing control and requires two dedicated share signal lines to be distributed throughout the backplane to all power supplies in the power array.
- Droop share control (DS option)
This method eliminates the need for share control lines and relies on output voltage adjustment and backplane symmetrical power layout for proper sharing.

MIL-STD-461, CE-102 Test Results

Vin=28V, 100% Output load, No external filtering

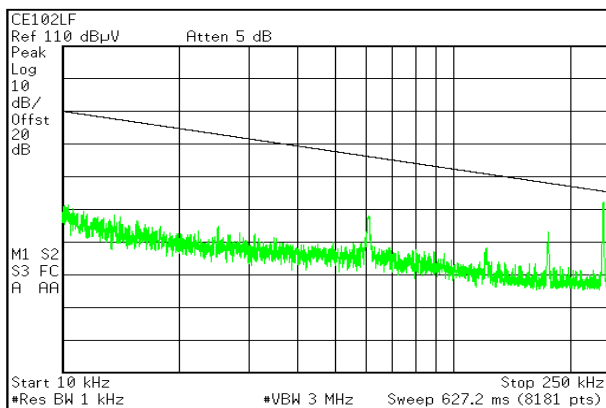

Fig. 13: CE102 low frequency band scan

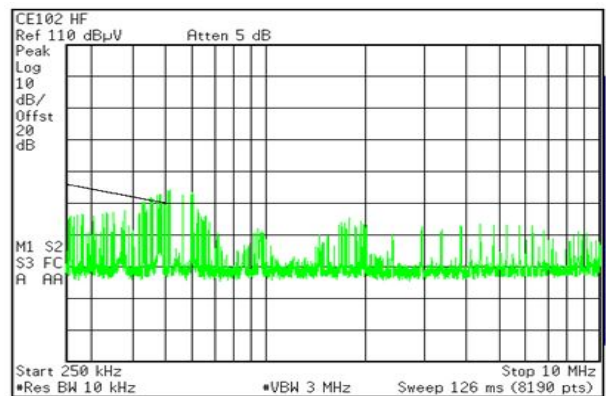

Fig. 14: CE102 high frequency band scan

Input and Output Connectors Information

P1

CONNECTOR, POWER/SIGNAL
MANUFACTURER: T.E. CONNECTIVITY (TYCO).
MANUFACTURER'S P/N: 6450839-6

6U P1 CONNECTOR PIN OUT CURRENT RATING				
PIN NUMBER	RATED CURRENT (A)	PIN NAME	FUNCTION	COMMENTS
P10	40	PO1	+12VDC	
P9	40	PO2	+12VDC	
A9	<1A	PO1_SENSE	+SENSE, +12VDC	CONNECT TO +12VDC
B9	<1A	PO2_SENSE	N/U	
C9	<1A	PO3_SENSE	+SENSE, +5VDC	CONNECT TO +5VDC
D9	<1A	UDO	N/U	
A8	<1A	PO1_SENSE_RTN	SENSE RTN,+12VDC	CONNECT TO +12VDC RTN
B8	<1A	PO2_SENSE_RTN	N/U	
C8	<1A	PO3_SENSE_RTN	SENSE RTN, +5VDC	CONNECT TO +5VDC RTN
D8	<1A	UD1	N/U	
A7	<1A	PO1_SHARE	SHARE+, +12VDC	CONNECT TO +SHARE AND -SHARE PINS OF ALL PARALLELED CARDS
B7	<1A	PO2_SHARE	SHARE-, +12VDC	
C7	<1A	PO3_SHARE	N/U	
D7	<1A	SIGNAL_RETURN	OUTPUT RTN COM	MUST BE CONNECTED TO PWR RTN'S COMMON POINT
P8	40	POWER_RETURN	+12VDC RETURN	COMMON RETURN FOR +12VDC AND +12V_AUX
P7	40	POWER_RETURN	+12VDC RETURN	
A6	<1A	SM2	N/U	
B6	<1A	SM3	N/U	
C6	<1.5A	-12V_AUX		USE P1 AS RETURN PIN
D6	<1A	SYSRESET*	N/U	
A5	<1A	GAP*	N/U	
B5	<1A	GA4*	N/U	
C5	<1A	SM0	N/U	
D5	<1A	SM1	N/U	
A4	<1A	GA3*	N/U	
B4	<1A	GA2*	N/U	
C4	<1A	GA1*	N/U	
D4	<1A	GA0*	N/U	
A3	<1A	UD2	N/U	
B3	<1.5A	+12V_AUX		USE P7, P8 AS RETURN PINS
C3	<1A	NED	N/U	
D3	<1A	NED_RETURN	N/U	
P6	40	PO3	+5VDC	
P5	40	PO3	+5VDC	
P4	40	POWER_RETURN	+5VDC RETURN	
P3	40	POWER_RETURN	+5VDC RETURN	
A2	<1A	VBAT	N/U	
B2	<1A	FAIL*	OUT VOLTAGES MON	HIGH OK, LOW FAULT
C2	<1A	INHIBIT* [1]	+12V DISABLE	CONNECT TO SIGNAL RTN TO DISABLE +12VDC OUTPUT
D2	<1A	ENABLE* [1]	+28V ENABLE	CONN TO SIG_RTN TO ENABLE INPUT PWR. (NO EFFECT ON +3.3V OUTPUT)
A1	<1A	UD3	N/U	
B1	<1A	UD4	N/U	
C1	<1A	UD5	N/U	
D1	<1A	UD6	N/U	
P2	40	3.3V_AUX	+3.3V/15A	
P1	40	POWER_RETURN	+3.3V,-12V AUX RTN	COMMON RTN, +3.3V AND -12V_AUX

[1] ACTIVE LOW OPERATION

PART NUMBER	ROWS	POWER		SIGNAL		POWER				SIGNAL				POWER		SIGNAL			POWER	
		P1	P2	1	2	P3	P4	P5	P6	3	4	5	6	P7	P8	7	8	9	P9	P10
6450839-6	D			J	J					J	J	J	J			J	J	J		
	C			K	K					K	K	K	K			K	K	K		
	B			N	N					N	N	N	N			N	N	N		
	A			S	S					S	S	S	S			S	S	S		
2ACP+8S+4ACP+16S+2ACP+12S+2ACP																				

Fig. 15: Output connector P1, pin assignment and signal description

P0

CONNECTOR, POWER
MANUFACTURER: T.E. CONNECTIVITY (TYCO)
MANUFACTURES P/N: 6450833-7

6U P0 CONNECTOR PIN OUT CURRENT RATING

PIN NUMBER	RATED CURRENT (A)	PIN NAME	FUNCTION	NOTES
P7	40	+DC_IN	INPUT POWER (POS)	+28VDC NOMINAL INPUT VOLTAGE (18V TO 36V)
P6	40	+DC_IN	INPUT POWER (POS)	
P5	40	-DC_IN	INPUT POWER RTN	
P4	40	-DC_IN	INPUT POWER RTN	
P3	40	POS_FILT_OUT	N/U	
P2	40	NEG_FILT_OUT	N/U	
P1	40	CHASSIS		

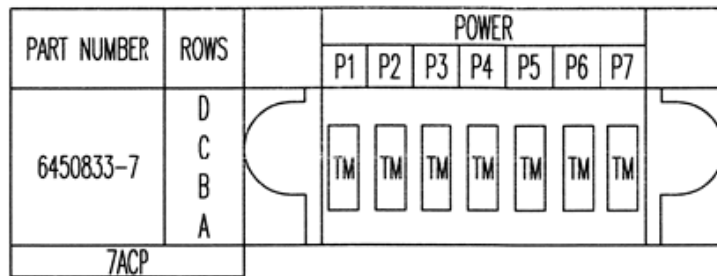

Figure 16: Input connector P0, pin assignment and signal description

Mechanical drawings:

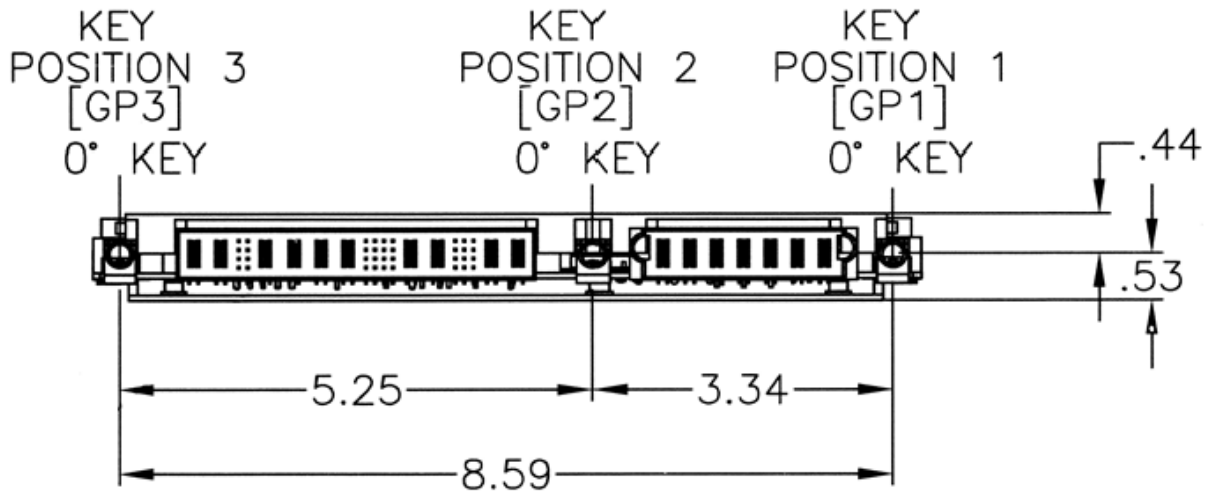

Figure 17: VPXtra 1000CM Power Supply, Connector View

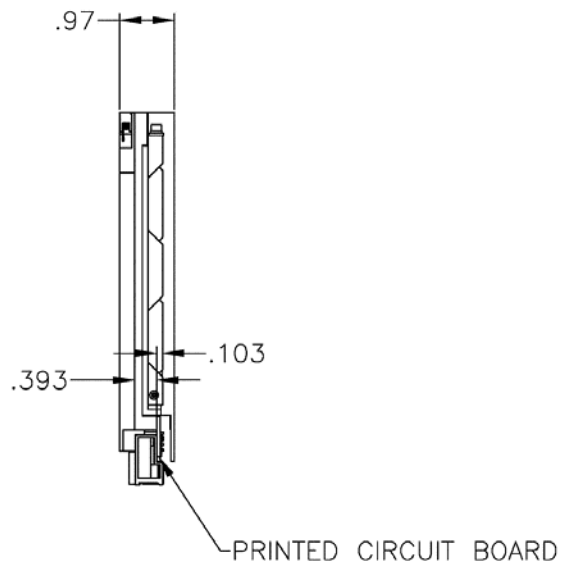

Figure 18: VPXtra 1000CM Power Supply, Side View

EJECTORS SHOWN IN
CLOSED POSITION



Figure 19: VPXtra 1000CM Power Supply, Face View

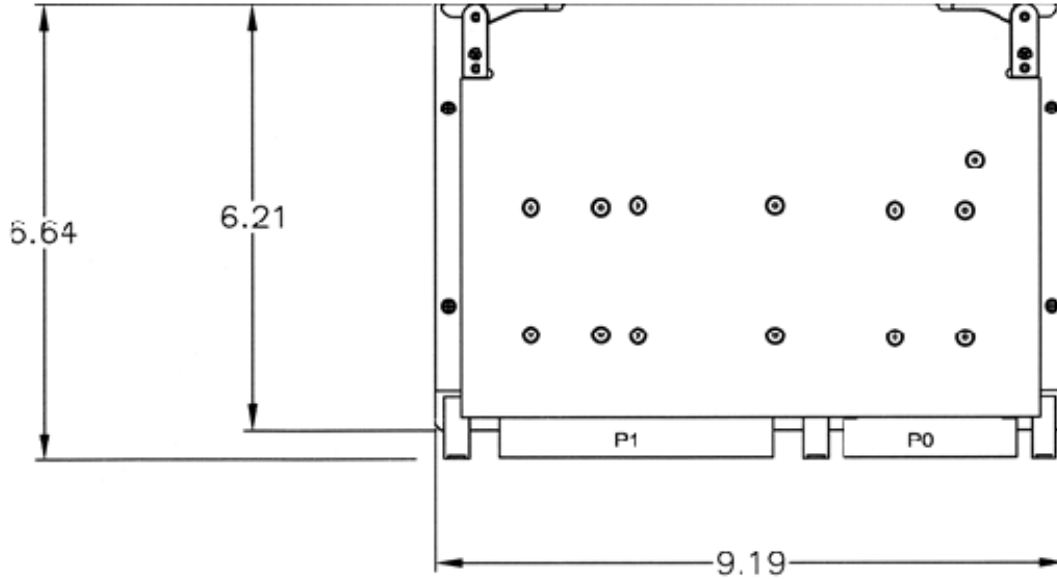
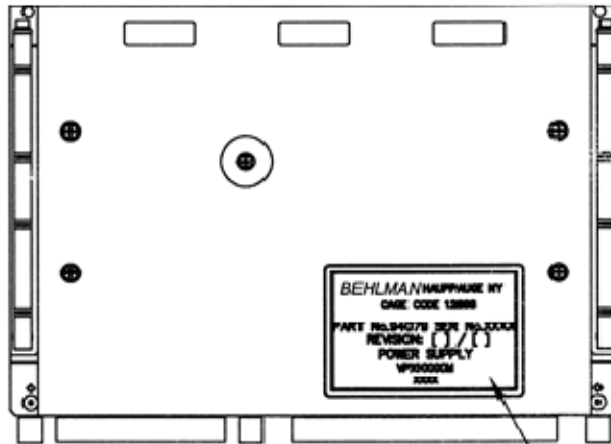

Figure 20: VPXtra 1000CM Power Supply, Top View



BEHLMAN I.D. LABEL

Figure 21: VPXtra 1000CM Power Supply, Bottom View