

FEATURES

- Open VPX VITA 62 compliant
- 6U VPX, 1.0" pitch single slot
- Wide input range: 18-36V
- Input transient protection
- High power DC output: 12V/80A
- Auxiliary DC output: 3.3V/15A
- Low noise & ripple
- Parallelable output (12V/80A)
- Input-output isolation
- Excellent load regulation
- Overcurrent, Overvoltage, Over temperature protection
- Efficiency of 90% typical
- High power density
- Conduction cooled at card edge
- Conformal coating on PCB
- MIL-STD-461F, CE-102 compliant
- ENABLE*, INHIBIT* controls per VITA 62
- Output voltage FAIL* signal
- LED indication



OVERVIEW

The Behlman VPXtra™1000CD series COTS DC to DC power supply is a rugged, highly reliable, conduction cooled, switch mode unit built for high-end industrial and military applications. The VPXtra™1000CD is a VITA 62, Open VPX compliant, 6U, power supply that delivers 1000 Watts of DC power. It provides 12V high power and 3.3V auxiliary power outputs. The 12V output can be paralleled for higher power and redundancy. VPXtra1000CD accepts 28VDC input IAW MIL-STD-704, but it operates over much wider input voltage range, 18-36V.

The VPXtra™1000CD power supply has no minimum load requirement and has overvoltage and short circuit protection as well as over current and thermal protection. The power supply is designed to support the rigors of mission critical airborne, shipboard, vehicle and mobile applications.

Designed and manufactured with Xtra-Cooling™ technology, Xtra-Reliable™ design and Xtra-Rugged™ construction makes the Behlman VPXtra™ 1000CD your best choice.

Absolute Maximum Ratings:

(Stresses above those listed below may cause permanent damage to the unit)

Parameter	Notes	Min	Typical	Max	Units
Input Voltage		18		36	V
Input Current	See figure 9			83	A
Operating Temperature	Measured at Card Edge	-40		71	°C
Storage Temperature		-40		105	°C
Isolation Voltage	Input to Output			500	V
Isolation Voltage	Input to Case			500	V
Isolation Voltage	Output to Case			100	V
Isolation Resistance	Input to Case	10			MΩ

Input Characteristics:

Parameter	Notes	Min	Typical	Max	Units
Operating Input Voltage Range		18	28	36	V
Turn-On Threshold			17.6		V
Turn-Off Threshold			16.9		V
Input Standby Current	28V Input, Enable De-asserted (Input Off), Inhibit Asserted (Output Off)		0.1		A
Input Standby Current	28V Input, Enable Asserted (Input On), Inhibit Asserted (Output Off)		0.14		A
Input No Load Current	28V Input, Enable Asserted (Input On) and Inhibit De-asserted (Output On)		0.72		A

Output Characteristics, +12V/80A Output:

Parameter	Notes	Min	Typical	Max	Units
Output Voltage Set Point		11.80	12.00	12.17	V
Line Regulation	(18-36V input range, 100% Output Load)		0.05	0.25	%
Load Regulation	(28V input)		0.05	0.25	%
Output Ripple/Noise Peak to Peak	See Note 1		80	120	mVp-p
Output Ripple/Noise RMS	See Note 1			25	mV _{rms}
Max. Capacitive Load				12,000	uF
Output Current Range		0		80	A
Output Voltage Remote Sense Range	Maximum DCR Losses to Remote Sense Connection			10	%
Output Overvoltage Protection		14.2	14.8	15.4	V
Output Overcurrent Protection		92	105	110	A
Transient Response	See Figures 3,5				

Output Characteristics, +3.3V Aux /15A Output:

Parameter	Notes	Min	Typical	Max	Units
Output Voltage Set Point		3.267	3.300	3.333	V
Line Regulation	(18-36V input range, 100% Output Load)		0.1	0.3	%
Load Regulation	(28V input)		0.75	1	%
Output Ripple/Noise Peak to Peak	See Note 1			50	mVp-p
Output Ripple/Noise RMS	See Note 1			25	mV _{rms}
Max. Capacitive Load				12,000	uF
Output Current Range		0		15	ADC
Output Overvoltage Protection		4.0	4.3	4.6	VDC
Output Overcurrent Protection		16.5	18	20	ADC
Transient Response	See Figure 4				

General Characteristics:

Parameter	Notes	Min	Typical	Max	Units
Power	See Figure 8		1000		W
Efficiency 100% Load	12V@80A, 3.3VAux@15A, 28V Input.(Fig.6)		90		%
Efficiency 50% Load	12V@40A, 3.3VAux@7.5A, 28V Input		91		%
Turn-On Delay, 3.3V output	From application of input power (ENABLE* is asserted)		40		ms
Turn-On Delay, 12V output	From INHIBIT* de-assertion		65		ms

Controls and Signals (per VITA 62):

Name	Function	Description
ENABLE* (Input)	Input power control	Active Low, referenced to SIG RTN. When asserted, internal input power bus is enabled
INHIBIT* (Input)	Output power control for 12V output	Active Low, referenced to SIG RTN. When asserted, 12V output is disabled.
FAIL* (Output)	Reports out of tolerance output voltages	Open Drain Output (40V, 10mA) with internal pull-up to 3.3VAux. Logic low indicates output voltage(s) out of tolerance.

Output power status vs. input power and control signals:

Input Power	ENABLE*	INHIBIT*	12V output	3.3VAux output
Not present	X	X	OFF	OFF
Present	Not asserted (high)	X	OFF	ON
Present	Asserted (low)	Asserted (low)	OFF	ON
Present	Asserted (low)	Not asserted (high)	ON	ON

Indicators:

Indicator	Description
DC IN OK (Green LED)	Indicates Input Power is present
OUT FAULT (Red LED)	Indicates at least one Output Voltage is outside of specified range
DC OUT (Green LED)	Indicates 12V output is enabled
TEMP FAULT (Red LED)	Indicates Power Supply is nearing over temperature shutdown point

Note 1: Ripple and noise measured at output connector, across parallel connection of 10uF tantalum and 0.1uF ceramic capacitors, 20MHz Bandwidth

Note 2: All measurements are performed at Nominal Input (28VDC) and at ambient temperature of 25° C, unless otherwise specified.

Output voltages start up sequence

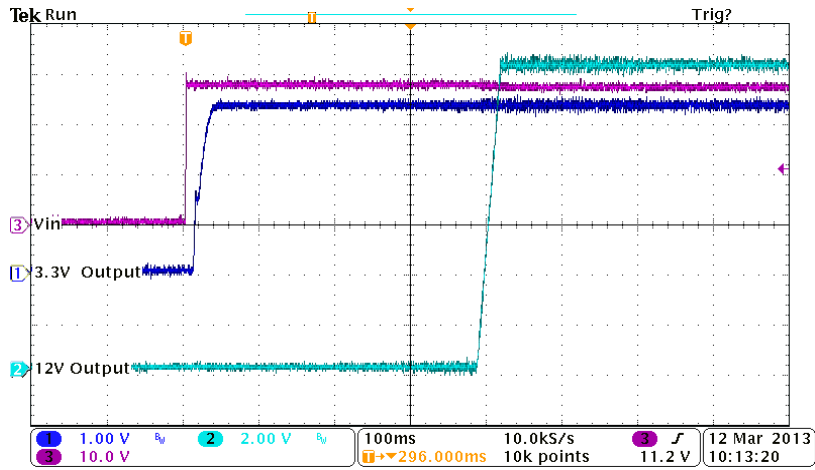

Figure 1: 3.3VAux and 12V Turn-on delay from application of input power, ENABLE* asserted, INHIBIT* de-asserted

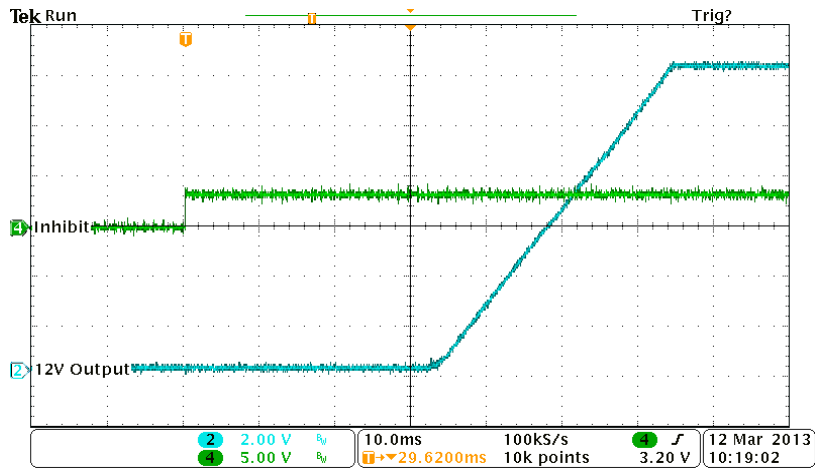

Figure 2: 12V output Turn-on delay from INHIBIT de-assertion

Output voltages load transient response:

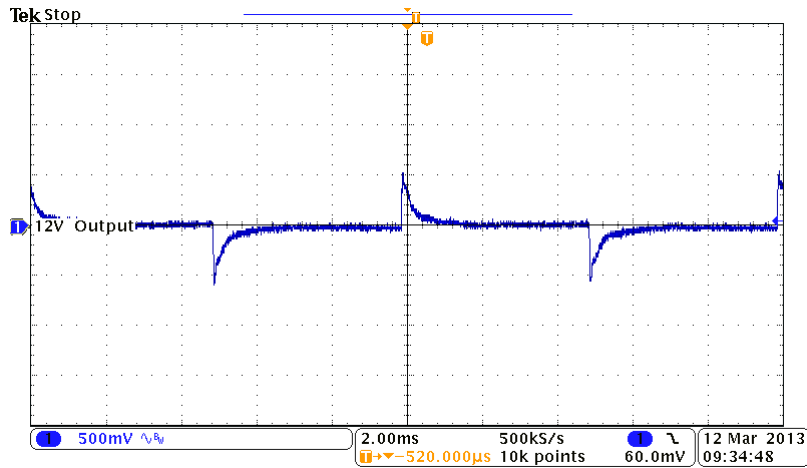

Figure 3: 12V output transient response, 50-75% load change

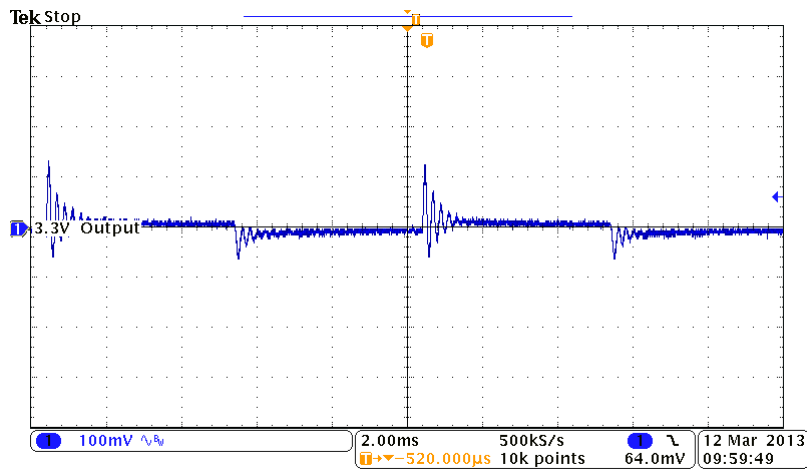

Figure 4: 3.3VAux output transient response, 50-75% load change

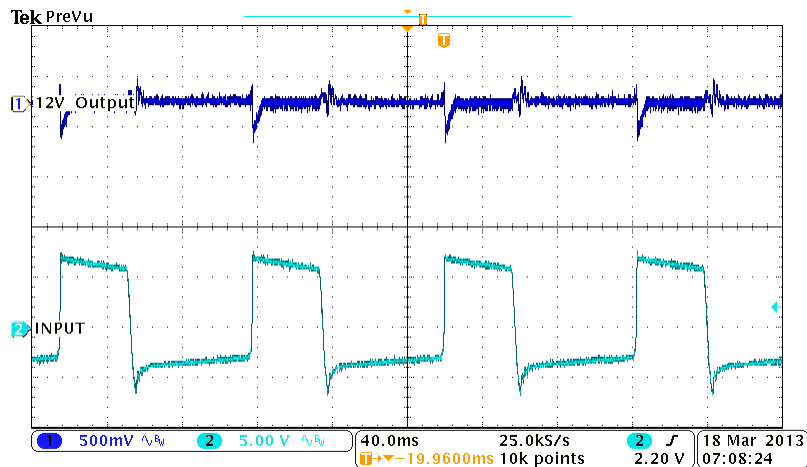

Figure 5: 12V output transient, Input line change, 24V to 34V

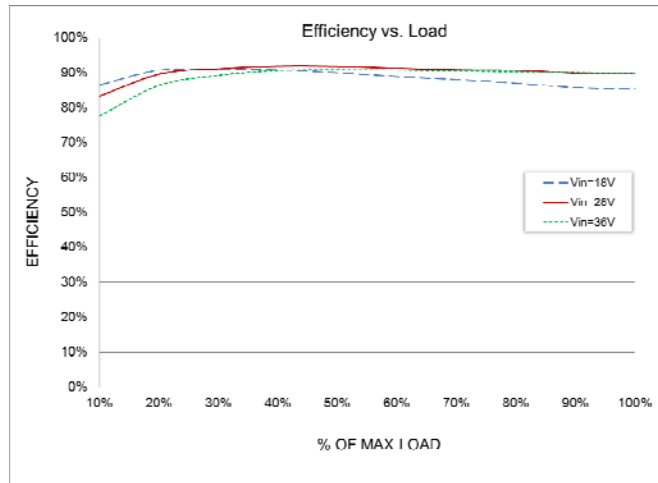

Figure 6: Efficiency vs. Load for Minimum, Nominal and Maximum input voltage

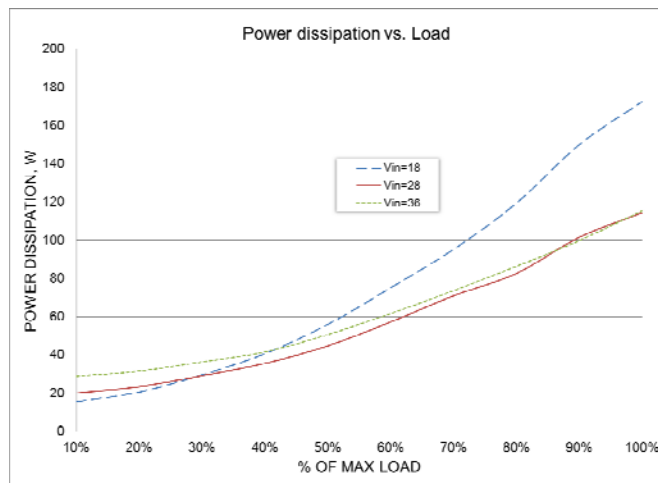

Figure 7: Power dissipation vs. Load for Minimum, Nominal and Maximum input voltage

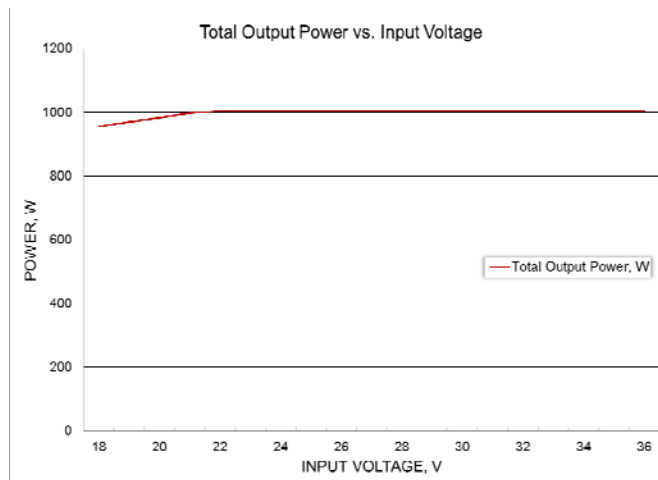

Figure 8: Maximum Output Power vs. Input Voltage (71°C Card Edge Temperature)

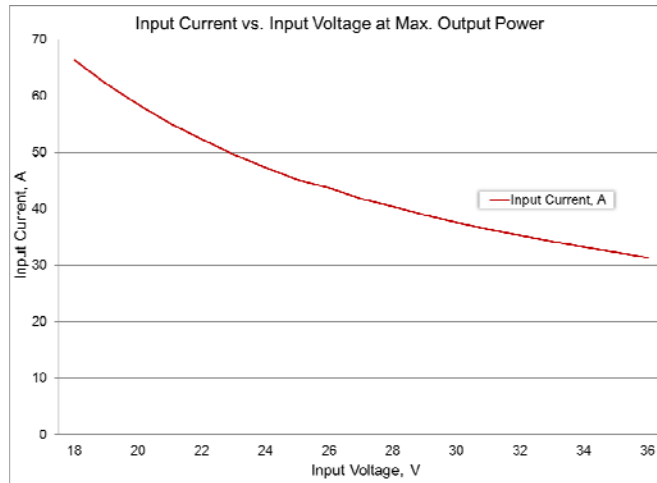

Figure 9: Input Current vs. Input Voltage at maximum output loads.

Paralleling options

Behlman VPXtra™1000CD series power supplies can be paralleled for higher output power and redundancy. Two options are available for the system designers:

- Digital share control (Standard)
Digital share control provides superior sharing control and requires two dedicated share signal lines to be distributed throughout the backplane to all power supplies in the power array.
- Droop share control (DS option)
This method eliminates the need for share control lines and relies on output voltage adjustment and backplane symmetrical power layout for proper sharing.

MIL-STD-461, CE-102 Test Results

Vin=28V, 100% Output load, No external filtering

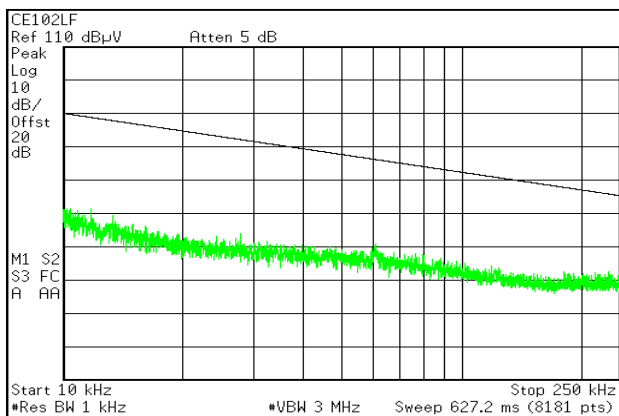

Fig. 10: CE102 low frequency band scan

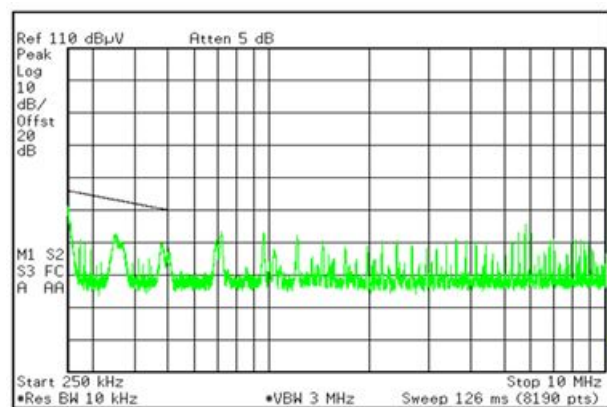

Fig. 11: CE102 high frequency band scan

Input and Output Connectors Information

P1

CONNECTOR, POWER/SIGNAL
MANUFACTURER: T.E. CONNECTIVITY (TYCO).
MANUFACTURES P/N: 6450839-6

6U P1 CONNECTOR PIN OUT CURRENT RATING					
PIN	NUMBER	RATED CURRENT (A)	PIN NAME	FUNCTION	COMMENTS
P10		40	PO1	+12VDC	
P9		40	PO2	+12VDC	
A9		<1A	PO1_SENSE	+SENSE +12V	CONNECT BOTH +SENSE LINES TO +12VDC
B9		<1A	PO2_SENSE	+SENSE +12V	
C9		<1A	PO3_SENSE	N/U	
D9		<1A	UDO	N/U	
A8		<1A	PO1_SENSE_RTN	SENSE RTN,+12VDC	CONNECT BOTH SENSE RTN LINES TO +12VDC RETURN
B8		<1A	PO2_SENSE_RTN	SENSE RTN,+12VDC	
C8		<1A	PO3_SENSE_RTN	N/U	
D8		<1A	UD1	N/U	
A7		<1A	PO1_SHARE	SHARE+, +12VDC	CONNECT TO +SHARE AND -SHARE PINS OF ALL PARALLELED CARDS
B7		<1A	PO2_SHARE	SHARE-, +12VDC	
C7		<1A	PO3_SHARE	N/U	
D7		<1A	SIGNAL_RETURN	OUTPUT RTN COM	MUST BE CONNECTED TO PWR RTN'S COMMON POINT
P8		40	POWER_RETURN	+12VDC RETURN	
P7		40	POWER_RETURN	+12VDC RETURN	
A6		<1A	SM2	N/U	
B6		<1A	SM3	N/U	
C6		<1.5A	-12V_AUX	N/U	
D6		<1A	SYSRESET*	N/U	
A5		<1A	GAP*	N/U	
B5		<1A	GA4*	N/U	
C5		<1A	SM0	N/U	
D5		<1A	SM1	N/U	
A4		<1A	GA3*	N/U	
B4		<1A	GA2*	N/U	
C4		<1A	GA1*	N/U	
D4		<1A	GA0*	N/U	
A3		<1A	UD2	N/U	
B3		<1.5A	-12V_AUX	N/U	
C3		<1A	NED	N/U	
D3		<1A	NED_RETURN	N/U	
P6		40	PO3	+12VDC	
P5		40	PO3	+12VDC	
P4		40	POWER_RETURN	+12VDC RETURN	
P3		40	POWER_RETURN	+12VDC RETURN	
A2		<1A	VBAT	N/U	
B2		<1A	FAIL*	+12/3.3V MONITOR	HIGH OK, LOW FAULT
C2		<1A	INHIBIT* [1]	+12V DISABLE	CONNECT TO SIGNAL RTN TO DISABLE +12VDC OUTPUT
D2		<1A	ENABLE* [1]	+28V ENABLE	CONNECT TO SIGNAL RTN TO ENABLE INPUT PWR TO +12VDC
A1		<1A	UD3	N/U	
B1		<1A	UD4	N/U	
C1		<1A	UD5	N/U	
D1		<1A	UD6	N/U	
P2		40	3.3V_AUX	+3.3V/15A	
P1		40	POWER_RETURN	+3.3V/15A RTN	

[1] ACTIVE LOW OPERATION

PART NUMBER	ROWS	POWER		SIGNAL		POWER				SIGNAL				POWER		SIGNAL			POWER	
		P1	P2	1	2	P3	P4	P5	P6	3	4	5	6	P7	P8	7	8	9	P9	P10
6450839-6	D			J	J					J	J	J	J			J	J	J		
	C	TM	TM	K	K	TM	TM	TM	TM	K	K	K	K	TM	TM	K	K	K	TM	TM
	B			N	N					N	N	N	N			N	N	N		
	A			S	S					S	S	S	S			S	S	S		
2ACP+8S+4ACP+16S+2ACP+12S+2ACP																				

Figure 12: Output connector P1, pin assignment and signal description

P0

CONNECTOR, POWER
MANUFACTURER: T.E. CONNECTIVITY (TYCO)
MANUFACTURES P/N: 6450833-7

6U P0 CONNECTOR PIN OUT CURRENT RATING

PIN NUMBER	RATED CURRENT (A)	PIN NAME	FUNCTION	NOTES
P7	40	+DC_IN	INPUT POWER (POS)	+28VDC NOMINAL INPUT VOLTAGE (18V TO 36V)
P6	40	+DC_IN	INPUT POWER (POS)	
P5	40	-DC_IN	INPUT POWER RTN	
P4	40	-DC_IN	INPUT POWER RTN	
P3	40	POS_FILT_OUT	N/U	
P2	40	NEG_FILT_OUT	N/U	
P1	40	CHASSIS		

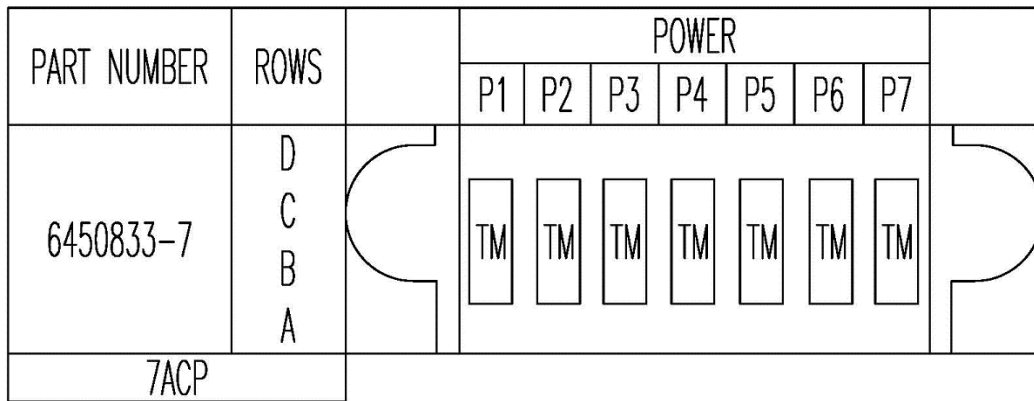

Figure 13: Input Connector P0, pin assignment and signal description

Mechanical drawings:

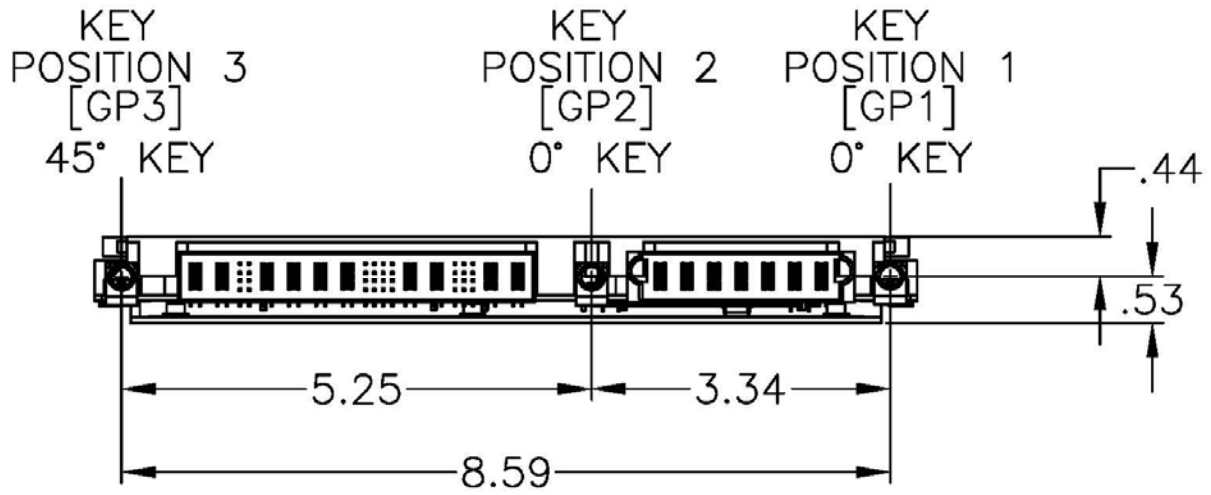

Figure 14: VPXtra 1000CD Power Supply, Connector View

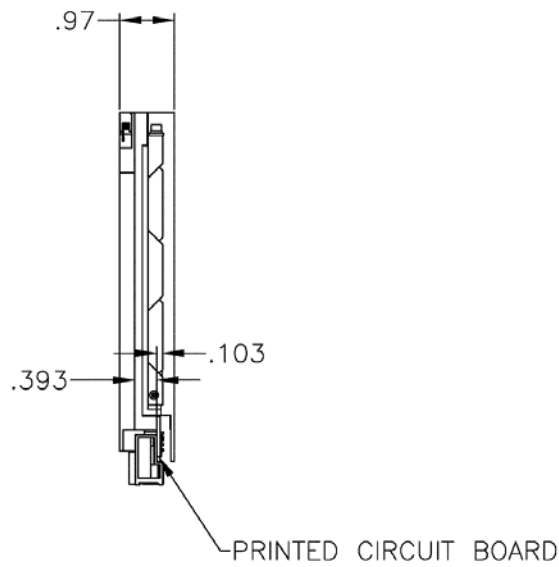

Figure 15: VPXtra 1000CD Power Supply, Side View

EJECTORS SHOWN IN
CLOSED POSITION

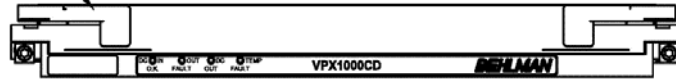

Figure 16: VPXtra 1000CD Power Supply, Face View

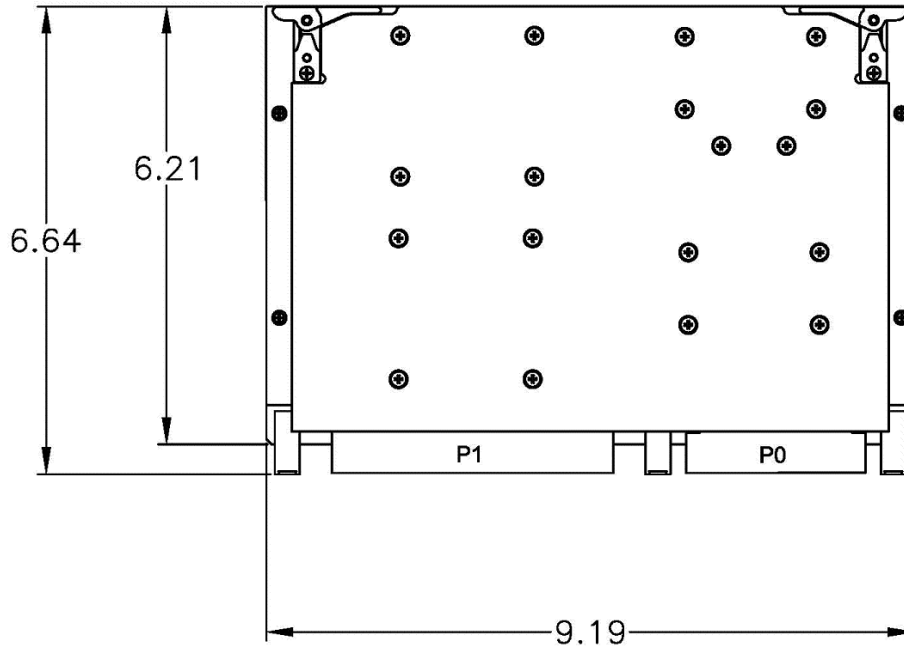
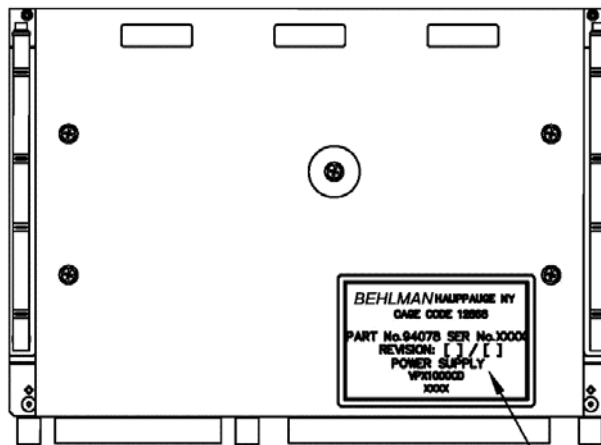

Figure 17: VPXtra 1000CD Power Supply, Top View



BEHLMAN I.D. LABEL

Figure 18: VPXtra 1000CD Power Supply, Bottom View